



www.ijoy.com

INTERACTIVE HEALTH



iJoy[®]
LIVE. PLAY. RELAX.

with Relief Zone

USE & CARE MANUAL

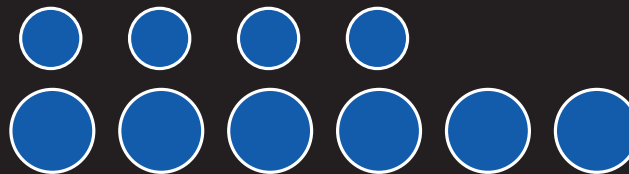
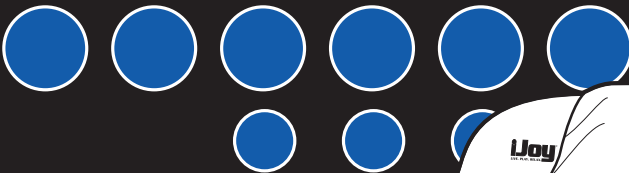

INTERACTIVE HEALTH

© Interactive Health, 2006
Patents Pending and intellectual property rights enforced.
No medical claims are warranted or implied by the use of this product.
iJoy is a registered trademark of Interactive Health.

www.interhealth.com

iJoy-550-A1

**Interactive Health®
Partners in Your Well-Being**

For decades, Interactive Health has been a leader in the field of massage products. We create state-of-the-art products that embrace the latest technology while applying the ancient healing art of massage. With today's fast-paced lifestyles, balancing your physical and mental needs requires the right mix of proper nutrition, exercise, and massage. Interactive Health® Massage Systems are vital components for achieving balance between physical and mental well-being.

To learn more about our company and our products, we invite you to visit us on the Internet at: www.interhealth.com or call our Customer Service Representatives at 800-355-2762.



HTT, recommended by professionals, designed for you.



"HTT" is the preferred technology of the ACCO.
www.accoweb.org



iJoy®
LIVE. PLAY. RELAX.

with Relief Zone

AN EXCELLENT
CHOICE!

YOU HAVE PURCHASED A TICKET TO
TRANQUILITY – CONGRATULATIONS!

Your iJoy® chair is the perfect bridge between state-of-the-art technology and the ancient healing art of massage. It's a key ingredient for a balanced life—and it's right in your own home!

Your iJoy® chair incorporates Human Touch Technology®—the very latest Robotic Massage® system. It emulates the same techniques used by massage and chiropractic professionals for back and spinal care. It's hard to believe it's not human!

To ensure that you don't overlook any of your chair's features, and that you use it safely, read this manual carefully. Then sit back, relax, and iJoy!

KEEP IT

SAFE

Read all instructions before using this product.

WARNING: Do not put hands or fingers near the massage mechanism or rollers while this product is running. Touching the mechanism can result in injury from the rollers squeezing together.

DANGER: To reduce the risk of electrical shock

Always unplug this product from the electrical outlet immediately after using and before cleaning. Do not reach for this product if it has fallen into water. Unplug immediately.

WARNING: To reduce the risk of burns, fire, electric shock or injury to persons

- This product should never be left unattended when plugged in.
- Unplug from outlet when not in use, and before putting on or taking off parts.
- Do not operate under blanket or pillow. Excessive heating can occur and cause fire, electric shock, or injury to persons.
- Close supervision is necessary when this product is used by, on, or near children, invalids, or disabled persons.
- Use this product only for its intended use as described in this manual. Do not use attachments not recommended by the manufacturer.
- Never operate this product if it has a damaged cord or plug, if it is not working properly, if it has been dropped or damaged, or dropped into water. Return this product to a service center for examination and repair.
- Always keep the power cord away from heated surfaces.
- Never operate this product with the air openings blocked. Keep the air openings free of lint, hair, and the like.

- Never drop or insert any object into any opening.
- Do not use outdoors.
- Do not operate where aerosol (spray) products are being used or where oxygen is being administered.
- To disconnect, turn all controls to the OFF position, then remove plug from outlet.
- Do not massage abdomen when pain is present or if you are pregnant.
- Do not massage any area of the body that is swollen, inflamed or covered with skin eruptions. Do not use on unexplained calf pain.
- Do not use this product when standing on a damp floor, or when any part of the body is in contact with plumbing or any similar ground.
- Always connect this product to a properly grounded electrical outlet.
- This product is designed to operate on standard 120 Volt 60 Hz house current.
- Do not use this product if noise above normal sound is heard.
- This product is designed for personal in-home use. Commercial use will void warranty.

Safety Precautions

- Comfortable clothing is recommended while using this product.
- This product was meant to be used in a relaxed position. Never force any body part into the backrest area while the rollers are moving.
- Do not allow children to use this product.
- If you feel any abnormal discomfort during the operation of this product, turn off the power immediately and do not use the product. Consult your physician.
- Do not sit on the controller.
- Do not pull on the AC cord.
- Always confirm that there are no obstacles behind the product and that there is sufficient space to recline.
- When using this product after it has been in storage, check to see that the product is operating properly prior to sitting in the product.

- **Do not attempt to repair this product yourself.** If a malfunction occurs, please contact Interactive Health at (800) 355-2762.

SAVE THESE INSTRUCTIONS

For all grounded cord-connected products:

Grounding methods:

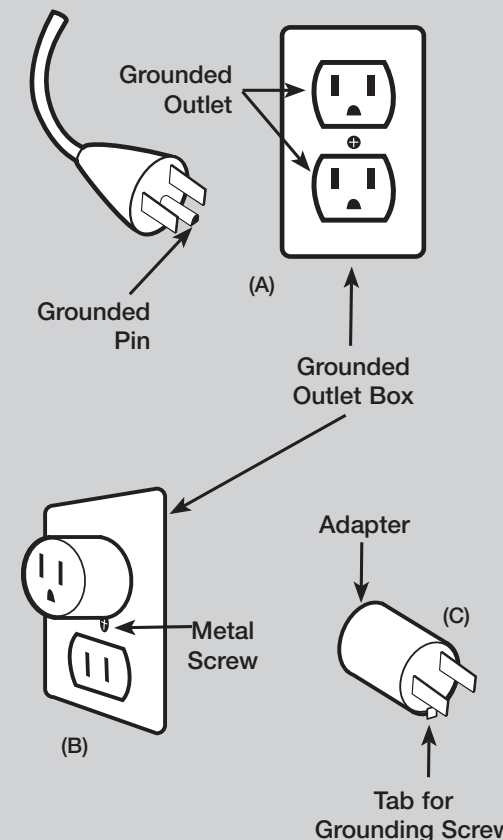

Grounding Instructions:

This product must be grounded. If it should malfunction or breakdown, grounding provides a path of least resistance for electrical current to reduce the risk of electric shock. This product is equipped with a cord having an equipment-grounding conductor and a grounding plug. The plug must be plugged into an appropriate outlet that is properly installed and grounded in accordance with all local codes and ordinances.

WARNING: Improper connection of the equipment-grounding conductor can result in a risk of electronic shock. Check with a qualified electrician or serviceman if you are in doubt as to whether this product is properly grounded. Do not modify the plug provided with the product – if it will not fit the outlet, have a proper outlet installed by a qualified electrician.

This product is for use on a normal 120-volt circuit and has a grounding plug that looks like the plug illustrated in sketch (A). A temporary adapter that looks like the adapter used in sketches (B) and (C) may be used to connect this plug to a 2-pole receptacle as shown in sketch (B), if a properly grounded plug is not available. The temporary adapter should be used only until a properly grounded outlet (sketch A) can be installed by a qualified electrician. The green colored, rigid ear tab or the like extending from the adapter must be connected to a permanent ground such as a properly grounded outlet box cover. Whenever the adapter is used, it must be held in place by a metal screw.

WARNING: This product is equipped with a thermal resetting protection device. This is an added safety feature to protect you and this product from overheating. If the product should suddenly stop and will not start, turn the main power switch, located on the back of the product, off and do not operate the product for at least 30 minutes. Failure to turn the product off may result in the product starting unexpectedly when the device cools.

GET

READY

Unpack the box

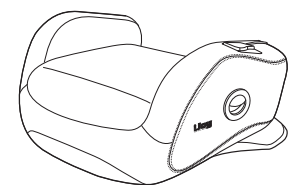

Chair base

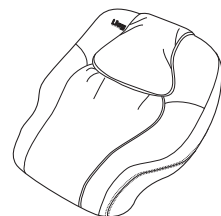

Backrest

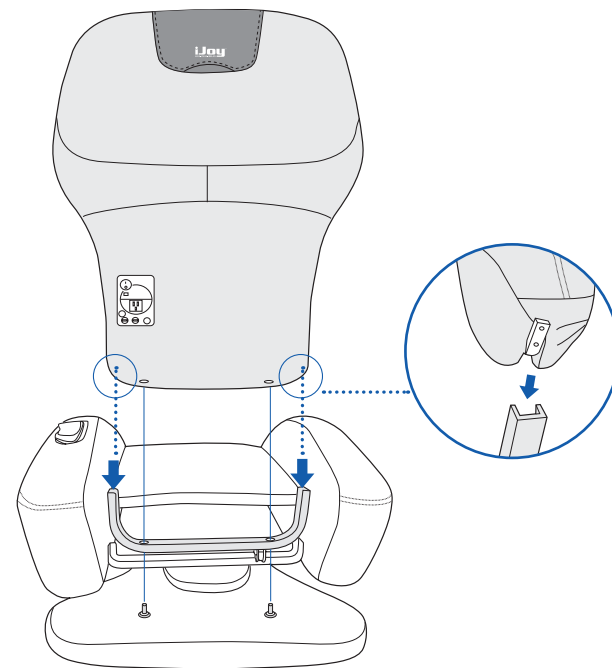

CAUTION: Be sure all cords and fingers are out of the way before installing the backrest, to avoid damage or injury.

1. Attach the backrest to the chair base

Before installing the backrest, remove the two screw knobs from the bottom of the backrest. Align the two guides on the lower sides of the backrest with the track on the chair base, then slide the backrest firmly onto the chair base. From the bottom of the backrest, install and hand-tighten the two screw knobs. Verify that the two screw knobs are installed and tightened before using the chair.

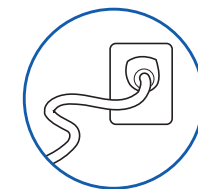

2. Plug it in

Plug the power cord into a grounded 110 VAC power source.

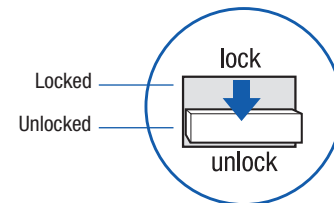

3. Child safety lock

Make sure child safety lock is set to Unlock.

Setting the **Child Safety Lock** to the Lock position prevents the power switch from being turned on. Keep the child safety lock in the Locked position when unattended, to prohibit children from using the chair.

4. Power on

Turn the master power switch to On (located on the back of the chair).

The iJoy® chair power panel offers a **convenience outlet**, which enables you to plug in a low-wattage appliance such as a lamp or laptop. Do not plug in appliances that use wattages higher than 1 AMP, such as a vacuum or a hair dryer.

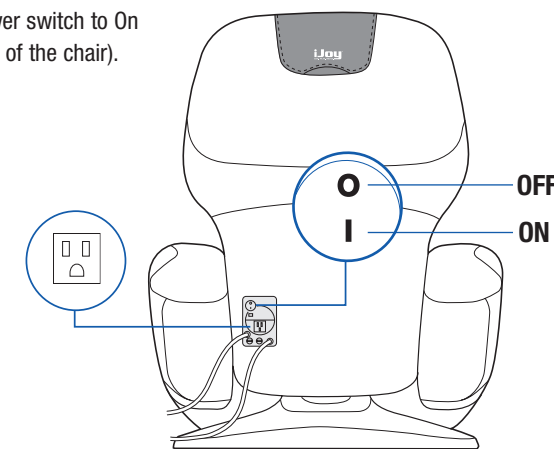

Your iJoy® massage chair

requires some simple assembly.

Simply attach the backrest to the chair base, plug it in, turn it on, and you're set to go!

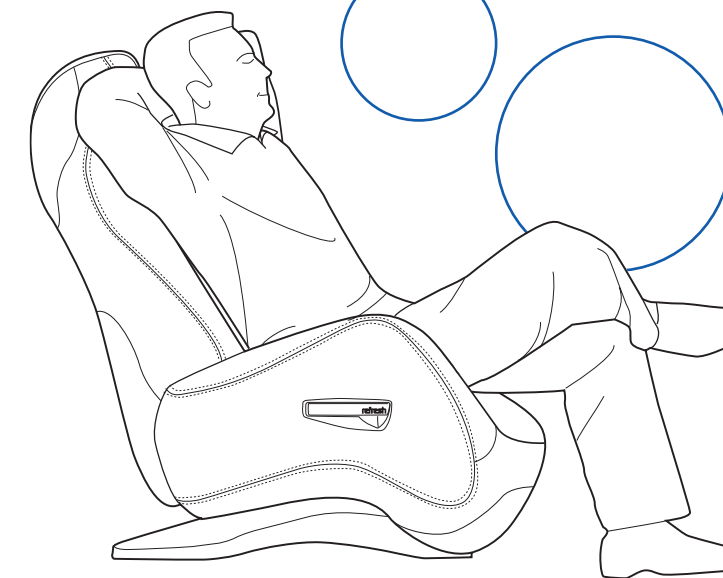

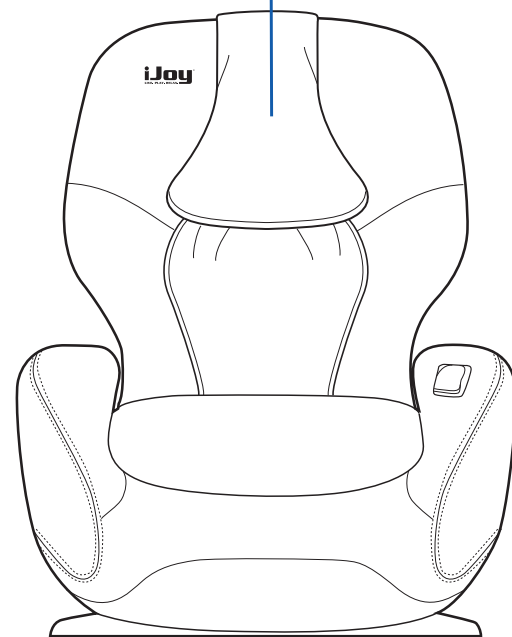

TAKE A SEAT

1. Get acquainted with the Relief Zone

Your iJoy® chair has a unique Relief Zone, providing superior contouring for neck and shoulder massage. To increase massage intensity in these areas, flip the head pillow over the headrest, settle your head and neck into the Relief Zone, and let the relief begin.

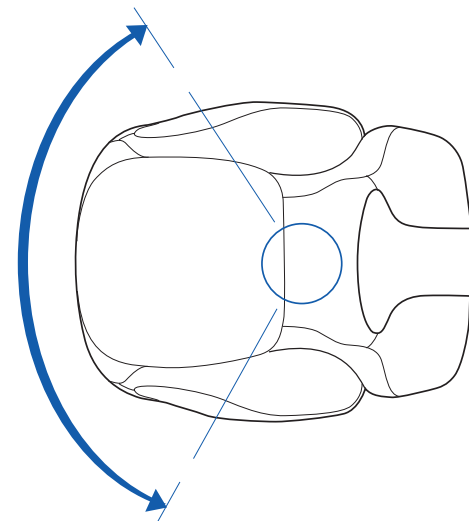
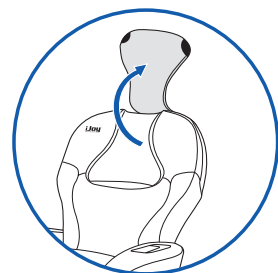

2. Try the Panoramic Swivel

Your iJoy® chair's rear-balanced pivot point lets you sit back, swivel, and enjoy the view.

3. Get comfortable

While sitting in the chair, adjust the backrest by pulling the backrest handle up. Lean backward or forward until you find a comfortable position. Release the handle.

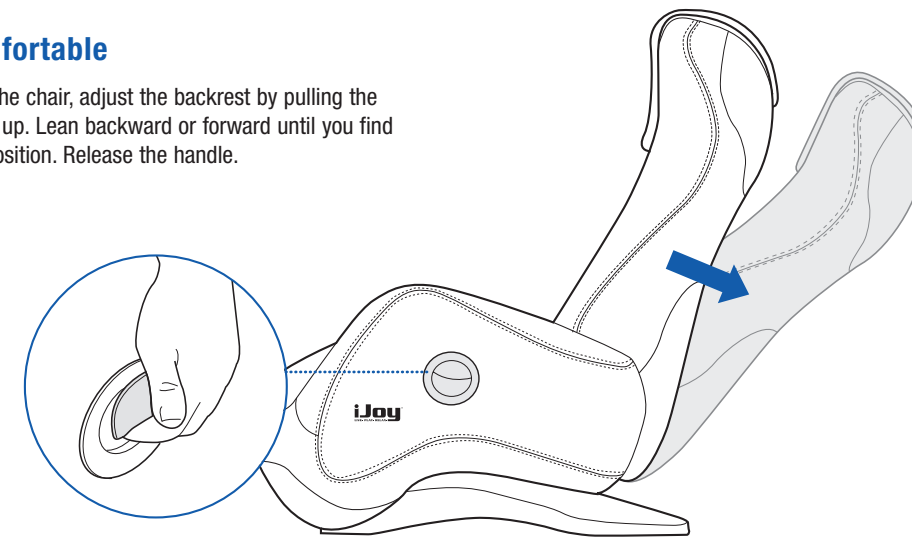

4. Check out the cupholder

The cupholder is located on the right-hand side of the chair. Pull gently outward on the front of the cupholder to deploy it. Be sure to push the cupholder back in when you're finished using it.

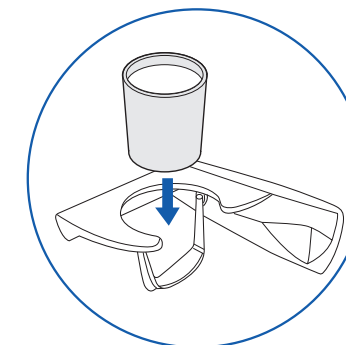
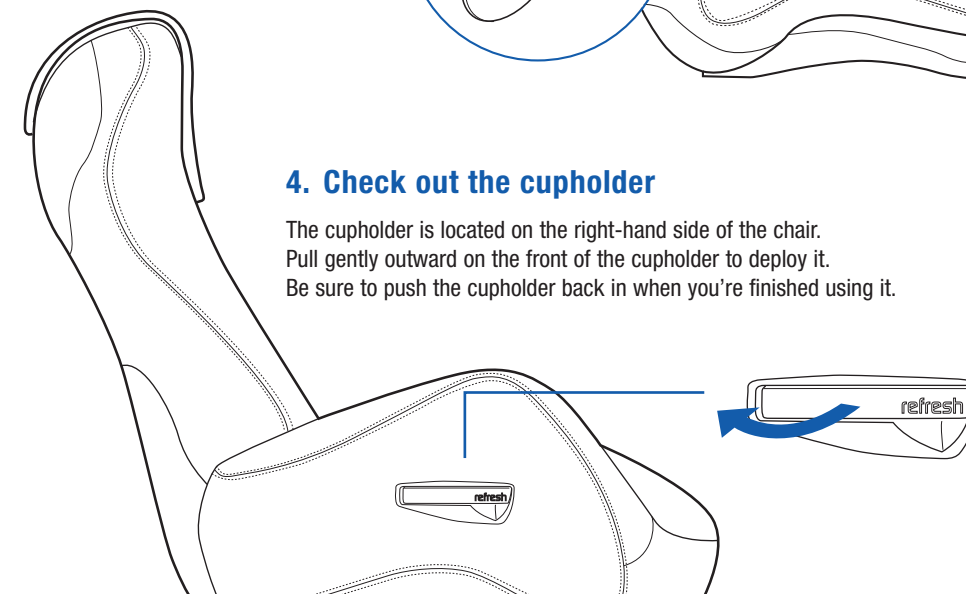

CAUTION: Do not place any items in or on the cupholder other than a beverage cup. It is not designed to hold heavy objects, such as books.

Using your iJoy® massage chair is easy!

Just take a seat, then adjust the backrest to a comfortable position. Experience the Relief Zone's truly advanced neck and shoulder massage. Give the unique panoramic swivel a try – it's a whole new perspective. Don't forget the cupholder, stored conveniently out of the way on the right-hand side of the chair.

All of these features work together to help you relax and refresh.

TAKE CONTROL

Position (up/down arrows) – Use this button along with one of the stationary massage modes, to set the massage rollers to the desired position on the backrest. You can press this button before or after selecting the massage mode.

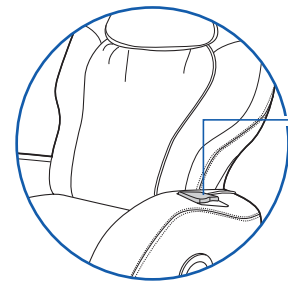

The remote control is conveniently located on the left-hand chair arm. Whether you use it in place, or remove it from its cradle, the buttons are ergonomically aligned for easy use.

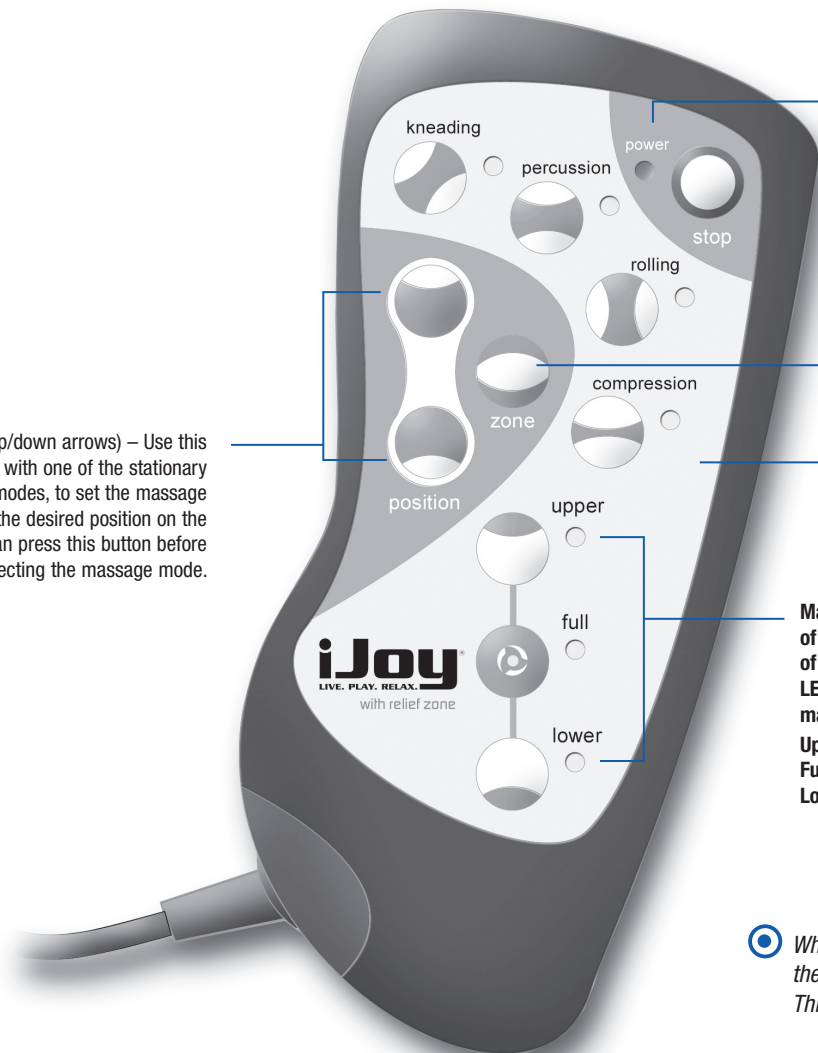

Power – lights to indicate that master power switch is on.

Zone – Press to limit your massage to a three-inch zone. Use the Position button to position the massage rollers to the desired area.

Massage Programs massage the specified area of your back for 15 minutes, using a variety of massage techniques. The corresponding LED lights on the remote to indicate which massage mode is currently in use.

Upper – massages just your upper back
Full – massages your entire back
Lower – massages just your lower back

When changing direction using the Position buttons, there is a slight pause while the chair gears shift. This is perfectly normal.

MASSAGE MODES

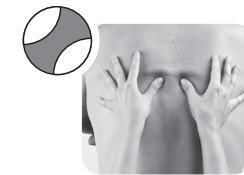

Kneading (stationary or rolling)

Kneading – kneads your back in small, circular motion on both sides of your spine simultaneously, relieving tension and soreness by lifting and stretching muscles. Kneading improves circulation and helps bring vital nutrients to the spinal area.

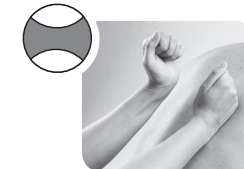

Percussion (stationary)

Percussion – alternating rapid-tapping strokes along the spine stimulate both spinal muscles and spinal joint areas, emulating the percussive massage technique used in sports medicine for deep muscle therapy. Percussion massage flexes spinal joints and relieves pressure on the spinal column, invigorating the entire back area.

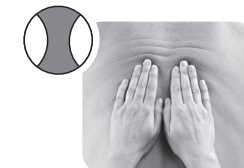

Use rolling mode on its own or along with Kneading or Compression modes.

Rolling – rolls gently up and down your back near your spine, gently alternating side-to-side, to warm up and loosen your muscles and prepare your back for deeper massage. Rolling massage relieves muscle tension, improves circulation and relaxes the back.



Compression (stationary or rolling)

Compression – presses on spinal muscles and spinal joint areas using alternating strokes and a gentle rocking motion, emulating a technique used in sports medicine and in spinal therapy by chiropractors. Compression spreads and puts pressure on deep muscle tissue, forcing it to relax, while the rocking motion loosens spinal joints. This technique aids in muscle and joint repair due to strain from exercise, long hours bent over a desk, or just day-to-day stress, and can improve mobility and overall posture.

Now choose a massage mode to suit your mood. Your iJoy® massage chair lets you customize your massage using a wide variety of massage modes. Choose from three stationary massage modes and a rolling massage, or combine them! Too tired to make a decision? Just select one of the three auto programs, which alternate between massage modes and target different areas of your back. For specific sore spots, position the massage rollers to target that spot. Your iJoy® massage chair offers maximum flexibility, to meet all of your back massage needs.

FOR A

STRONGER MASSAGE

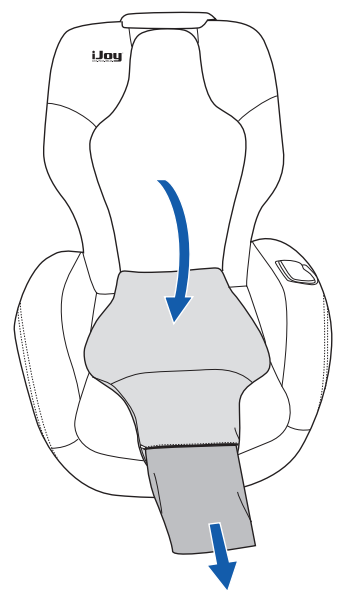

1. Flip the head pillow over the headrest, to the back of the chair.
2. Open the two backrest zippers, all the way down the backrest.
3. Pull the backrest pad outward, then open the zippered pocket inside.
4. Detach the massage-softening pad from the pocket hook and loop fasteners and gently remove the pad from the pocket, being careful not to tear the pocket.
5. Close the zippered pocket, then close the two backrest zippers.
6. Flip the head pillow back over the headrest and push down on the lower corners to secure it.

You can re-insert the massage-softening pad in the future, following these same steps. When reinserting the massage softening pad, fold the pad in length-wise before inserting it into the pocket. Once the pad is inside the pocket, use your hands to smooth it flat before closing the pocket zipper.

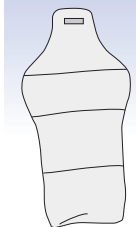
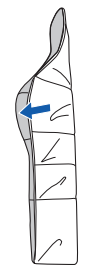

Want a stronger massage?
 You can easily remove the massage-softening pad that comes preinstalled in your iJoy® massage chair. But keep it handy, in case you want to replace it in the future.

iJoy Your iJoy® chair may have zippers that are closed with a plastic Security Tie. Cut the Security Tie with a nail clipper or other suitable instrument. Take care to not cut the chair upholstery.

TAKE

CARE AND MAINTENANCE

To keep your product working and looking its best, please follow these simple care guidelines.

General Maintenance

1. Be sure to disconnect the power cord from the electrical outlet before cleaning.
2. Do not use benzene, thinner or any other solvents on your massage chair.
3. Remove dust on the backrest or armrest with a vacuum.
4. If the backrest or armrests become soiled, wipe with a damp cloth, then a dry cloth.
5. Common upholstery cleaners may be used for tough stains.
6. When cleaning the controller or around the power switch, use a dry cloth only. Never use a damp cloth to clean the controller or power switch.
7. It is suggested that you cover the chair when not in use for a long period of time.
8. The mechanics of this product are specially designed and constructed to be maintenance free. No periodic lubrication or servicing are required.
9. Foreign objects should not be inserted between the massage nodes or the unit housing.
10. When not in use for a long period of time, we recommend that the power cord be coiled and that the unit be placed in an environment free of dust and moisture.
11. Do not store near heat or open flame. Do not leave this product exposed to direct sunlight for long periods of time. This may cause fading or damage.

Limited One (1) Year Warranty

Please read the following warranty information for important disclosures before using your new Human Touch Technology™, massage chair.

It is Interactive Health's mission to design, develop, manufacture and sell innovative, high quality massage products that create a better and healthier way of life. We appreciate your commitment to our mission and our products and are pleased to let you know that the Interactive Health®, HTT™ massage chair that you purchased comes with a limited one-year warranty. The warranty provides peace of mind that you are covered for mechanical or structural defects in workmanship within the coverage guidelines and limitations outlined below.

Coverage Guidelines:

The warranty begins on the original purchase date and consists of:

- Factory Service (Labor): Interactive Health® will supply packing materials, cover return shipping to Interactive Health®, repair parts covered by this warranty and labor for repair work and return shipping to purchaser when repairs are completed.
- Parts Only (Parts): Interactive Health® will supply repair parts that are covered by this warranty and return shipping to purchaser for repairs performed at the factory.
- Structural (Metal Frame): Interactive Health® will supply packing materials and repair parts covered by this warranty and return shipping to purchaser for repairs performed at the factory.

HTT™ Chair (iJoy® Models)	Factory Service	Parts	Structural
New Products (Original Packaging Only)	90 days	1 year	1 year
Refurbished Products	30 days	6 months	6 months
Floor Demos (including "out of box")	NONE	6 months	6 months

In the unlikely event that your chair malfunctions or requires repair, please contact your retailer. For USA customers only, please contact Interactive Health® Customer Service at (800) 355-2762 between the hours of 8:30AM and 5:00PM PST or cs@interhealth.com for assistance. You can also send a fax to customer service at (800) 840-2940.

All warranty service requires approval and authorization by Interactive Health®. Products require a Return Merchandise Authorization Number (RMA) for any returns to the factory. For returns, the consumer is responsible for packing the product in the original box or in approved packaging that is available for sale from Interactive Health. Shipping and freight coverage under this warranty requires scheduling by Interactive Health and only includes "curb-side" pickup/delivery. Products received without a valid RMA number or one clearly marked on the box will be refused.

General Limitations:

- The warranty is only valid within the United States and Canada provided the product has been operated according to the instructions accompanying it and has not been misused or damaged in any way that is beyond the control of Interactive Health.
- All service covered by this warranty must be approved by Interactive Health and repairs performed by authorized technicians.
- The warranty applies only to the massage chair; accessories or enhancements are not covered.
- Important exclusions apply to cosmetic items such as fabrics, woods, foams, padding, plastics covers, etc.
- Interactive Health is not responsible in any way for losses, damages, or inconvenience caused by equipment failure.
- For a complete listing of warranty coverage, exclusions, and limitations, visit www.interhealth.com.
- Warranties do not apply to rental, business, commercial, institutional, or other non-residential users.
- Separate warranty terms apply to used/refurbished products including those received out-of-box. Proof of purchase (original receipt) is required for all warranty repairs.

EXTENDED WARRANTIES:

Interactive Health® offers extended warranty programs to enhance ownership of the Interactive Health® chair! Extended warranty purchases are available within 90 days of purchase of iJoy® Chairs from either the retailer or direct from Interactive Health's Customer Service Department.

Please visit www.interhealth.com for the latest terms and pricing for extended warranties.

Specifications*

Operating Voltage:	AC 110-120 V / 0.8 Amps / 60 Hz	Total Massage Stroke Length:	23.5 In.
Power Consumption:	80 Watts	Rolling:	1 speed
Chair Size (Reclined):	57"L x 35" W x 26.5" H	Kneading:	1 speed
Weight: Chair	104 Lbs.	Compression:	1 speed
Recline Angle:	105 - 170 degrees	Percussion:	1 speed
Rotation (Swivel) Angle:	90 Degrees (Left to Right)	Cover Fabric Material:	Brushed polyester
Number of Massage Functions:	Four (4)	Maximum Load Weight:	285 Lbs.
Number of Auto Programs:	Three (3)	Accessories:	Massage Softening Pad
Massage Head Storage:	Auto at Top	Certifications :	cETL, CE
Automatic Timer Shut-Off:	15 minutes		

*Specifications are subject to change without prior notice.